

BRAGA

ILLUMINAZIONE

Via Soniga, 7

Tel. 030 691775 – Fax 030 691296

25080 NUVOLENTO / Brescia

Cod. Fisc. E P.i.v.a. IT 00737770172

Internet: www.fratellibraga.it

E-mail: info@fratellibraga.it

ART. 2128/S90-60-2



19

Nero
Black

/

24

Ferro
Iron

/

10

Bianco
White

/

14

Foglia Oro
Gold Leaf

13

Foglia Argento
Silver Leaf

22

Foglia rame
Copper leaf



10

Bianco
White



13

Foglia Argento
Silver Leaf



14

Foglia Oro
Gold Leaf



15

Grigio
Grey



19

Nero
Black



21

Grigio tortora
Dove grey



22

Foglia rame
Copper leaf



23

Ruggine
Rust



24

Ferro
Iron



28

Oro
Gold



29

Alluminio Spaz.
Brushed Alum.



30

Gunmetal



31

Rosé Spaz.
Brushed Rosé



32

Bronzo Spaz.
Brush. Bronze



33

Oro Spaz.
Brush. Gold



34

Rosé Verniciato
Painted Rosé



35

Bronzo Verniciato
Bronze Painted

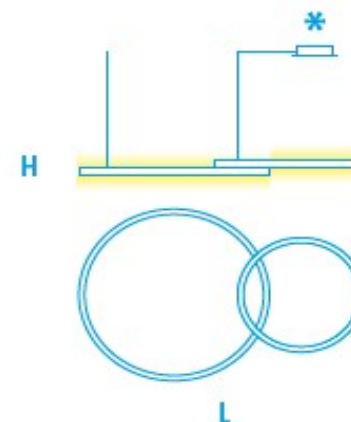

2128/S90-60-2

W 196 - Vac 230

Lm 11.800

M 2.700°K - C 3.000°K

W 4.000°K

H 80 mm

L 1.250x900 mm

L CAVI / CABLES 1.700 mm

DIMMERABILE / DIMMABLE

2128/S90-60-2 - D4

Taglio di fase / Phase Cut

2128/S90-60-2 - D6

1-10V - DALI - PUSH

2128/S90-60-2 - D7

ZigBee

2128/S90-60-2 - D8

CASAMBI

